

• C PV IEC / EN60898-1 GB 10963.1  
10~63A 30 7~14 In

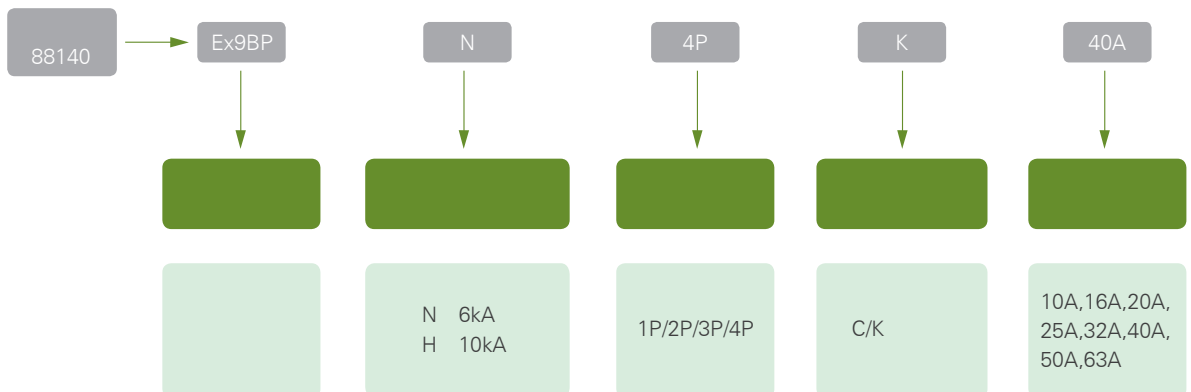



• K PV Ex9BP  
14~20 In

\*

m	2000	3000	4000	5000
V DC	3110	2799	2550.2	2332.5
4P V DC	1000	900	820	750
40 A	1× I <sub>n</sub>	0.96× I <sub>n</sub>	0.93× I <sub>n</sub>	0.9× I <sub>n</sub>
U <sub>imp</sub> kV	4	3.6	3	2.2













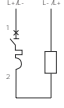

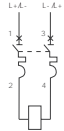
# MCB Ex9BP

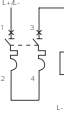
Ex9BP						
IEC/EN 60947-2 GB 14048.2						
		1P	2P	3P	4P	
A		63				
U <sub>e</sub>	V DC	250	500	750	1000	
I <sub>n</sub>	A	10 16 20 25 32 40 50 63				
U <sub>i</sub>	V	1000				
U <sub>imp</sub>	kV	4				
I <sub>cu</sub>	kA	N/H				
I <sub>cs</sub> %I <sub>cu</sub>		6/10				
		100%				
		C/K				
		20000				
		8500				
O~C		10000				
		1500				
		IP40				
		IP20				
		ON/OFF				
	mm <sup>2</sup>	1~35				
		-30~+70				
		2				
	m	≤2000				
		+20	95%	+40	50%	
		3				
		III				
		DIN				
x x	mm	a	18	36	54	72
		b	89	89	89	89
		c	72	74	74	74
		kg	0.12	0.24	0.36	0.48

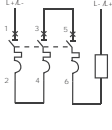

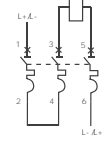

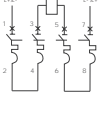
Ex9BP-N

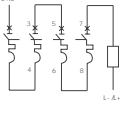
6kA —C K

C

		mm	A	V DC				
 <p>1P</p>		18	10	250	88047	Ex9BP-N 1P C 10A		
		18	16	250	88048	Ex9BP-N 1P C 16A		
		18	20	250	88049	Ex9BP-N 1P C 20A		
		18	25	250	88050	Ex9BP-N 1P C 25A		
		18	32	250	88111	Ex9BP-N 1P C 32A		
		18	40	250	88112	Ex9BP-N 1P C 40A		
		18	50	250	88113	Ex9BP-N 1P C 50A		
		18	63	250	88114	Ex9BP-N 1P C 63A		
		 <p>2P</p>		36	10	440	88051	Ex9BP-N 2P C 10A
				36	16	440	88052	Ex9BP-N 2P C 16A
36	20			440	88053	Ex9BP-N 2P C 20A		
36	25			440	88054	Ex9BP-N 2P C 25A		
36	32			440	88115	Ex9BP-N 2P C 32A		
36	40			440	88116	Ex9BP-N 2P C 40A		
36	50			440	88117	Ex9BP-N 2P C 50A		
36	63			440	88118	Ex9BP-N 2P C 63A		
 <p>2P</p>				36	10	440	90000	Ex9BP-N 2P C 10A New
				36	16	440	90001	Ex9BP-N 2P C 16A New
		36	20	440	90002	Ex9BP-N 2P C 20A New		
		36	25	440	90003	Ex9BP-N 2P C 25A New		
		36	32	440	90004	Ex9BP-N 2P C 32A New		
		36	40	440	90005	Ex9BP-N 2P C 40A New		
		36	50	440	90006	Ex9BP-N 2P C 50A New		
		36	63	440	90007	Ex9BP-N 2P C 63A New		
		 <p>3P</p>		54	10	750	88055	Ex9BP-N 3P C 10A
				54	16	750	88056	Ex9BP-N 3P C 16A
54	20			750	88057	Ex9BP-N 3P C 20A		
54	25			750	88058	Ex9BP-N 3P C 25A		
54	32			750	88119	Ex9BP-N 3P C 32A		
54	40			750	88120	Ex9BP-N 3P C 40A		
54	50			750	88121	Ex9BP-N 3P C 50A		
54	63			750	88122	Ex9BP-N 3P C 63A		
 <p>3P</p>				54	10	750	90008	Ex9BP-N 3P C 10A New
				54	16	750	90009	Ex9BP-N 3P C 16A New
		54	20	750	90010	Ex9BP-N 3P C 20A New		
		54	25	750	90011	Ex9BP-N 3P C 25A New		
		54	32	750	90012	Ex9BP-N 3P C 32A New		
		54	40	750	90013	Ex9BP-N 3P C 40A New		
		54	50	750	90014	Ex9BP-N 3P C 50A New		
		54	63	750	90015	Ex9BP-N 3P C 63A New		
		 <p>4P</p>		72	10	1000	88059	Ex9BP-N 4P C 10A
				72	16	1000	88060	Ex9BP-N 4P C 16A
72	20			1000	88061	Ex9BP-N 4P C 20A		
72	25			1000	88062	Ex9BP-N 4P C 25A		
72	32			1000	88123	Ex9BP-N 4P C 32A		
72	40			1000	88124	Ex9BP-N 4P C 40A		
72	50			1000	88125	Ex9BP-N 4P C 50A		
72	63			1000	88126	Ex9BP-N 4P C 63A		
 <p>4P</p>				72	10	1000	90016	Ex9BP-N 4P C 10A New
				72	16	1000	90017	Ex9BP-N 4P C 16A New
		72	20	1000	90018	Ex9BP-N 4P C 20A New		
		72	25	1000	90019	Ex9BP-N 4P C 25A New		
		72	32	1000	90020	Ex9BP-N 4P C 32A New		
		72	40	1000	90021	Ex9BP-N 4P C 40A New		
		72	50	1000	90022	Ex9BP-N 4P C 50A New		
72	63	1000	90023	Ex9BP-N 4P C 63A New				







K

	mm	A	V DC			
 1P	18	10	250	88063	Ex9BP-N 1P K 10A	
	18	16	250	88064	Ex9BP-N 1P K 16A	
	18	20	250	88065	Ex9BP-N 1P K 20A	
	18	25	250	88066	Ex9BP-N 1P K 25A	
	18	32	250	88127	Ex9BP-N 1P K 32A	
	18	40	250	88128	Ex9BP-N 1P K 40A	
	18	50	250	88129	Ex9BP-N 1P K 50A	
	18	63	250	88130	Ex9BP-N 1P K 63A	
	 2P	36	10	500	88067	Ex9BP-N 2P K 10A
		36	16	500	88068	Ex9BP-N 2P K 16A
36		20	500	88069	Ex9BP-N 2P K 20A	
36		25	500	88070	Ex9BP-N 2P K 25A	
36		32	500	88131	Ex9BP-N 2P K 32A	
36		40	500	88132	Ex9BP-N 2P K 40A	
36		50	500	88133	Ex9BP-N 2P K 50A	
36		63	500	88134	Ex9BP-N 2P K 63A	
36		10	500	90024	Ex9BP-N 2P K 10A New	
36		16	500	90025	Ex9BP-N 2P K 16A New	
36		20	500	90026	Ex9BP-N 2P K 20A New	
36		25	500	90027	Ex9BP-N 2P K 25A New	
36		32	500	90028	Ex9BP-N 2P K 32A New	
36		40	500	90029	Ex9BP-N 2P K 40A New	
36		50	500	90030	Ex9BP-N 2P K 50A New	
36		63	500	90031	Ex9BP-N 2P K 63A New	
 3P		54	10	750	88071	Ex9BP-N 3P K 10A
		54	16	750	88072	Ex9BP-N 3P K 16A
	54	20	750	88073	Ex9BP-N 3P K 20A	
	54	25	750	88074	Ex9BP-N 3P K 25A	
	54	32	750	88135	Ex9BP-N 3P K 32A	
	54	40	750	88136	Ex9BP-N 3P K 40A	
	54	50	750	88137	Ex9BP-N 3P K 50A	
	54	63	750	88138	Ex9BP-N 3P K 63A	
	54	10	750	90032	Ex9BP-N 3P K 10A New	
	54	16	750	90033	Ex9BP-N 3P K 16A New	
	54	20	750	90034	Ex9BP-N 3P K 20A New	
	54	25	750	90035	Ex9BP-N 3P K 25A New	
	54	32	750	90036	Ex9BP-N 3P K 32A New	
	54	40	750	90037	Ex9BP-N 3P K 40A New	
	54	50	750	90038	Ex9BP-N 3P K 50A New	
	54	63	750	90039	Ex9BP-N 3P K 63A New	
	 4P	72	10	1000	88075	Ex9BP-N 4P K 10A
		72	16	1000	88076	Ex9BP-N 4P K 16A
72		20	1000	88077	Ex9BP-N 4P K 20A	
72		25	1000	88078	Ex9BP-N 4P K 25A	
72		32	1000	88139	Ex9BP-N 4P K 32A	
72		40	1000	88140	Ex9BP-N 4P K 40A	
72		50	1000	88141	Ex9BP-N 4P K 50A	
72		63	1000	88142	Ex9BP-N 4P K 63A	
72		10	1000	90040	Ex9BP-N 4P K 10A New	
72		16	1000	90041	Ex9BP-N 4P K 16A New	
72		20	1000	90042	Ex9BP-N 4P K 20A New	
72		25	1000	90043	Ex9BP-N 4P K 25A New	
72		32	1000	90044	Ex9BP-N 4P K 32A New	
72		40	1000	90045	Ex9BP-N 4P K 40A New	
72		50	1000	90046	Ex9BP-N 4P K 50A New	
72		63	1000	90047	Ex9BP-N 4P K 63A New	

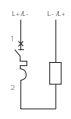

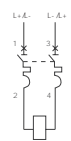

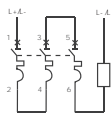
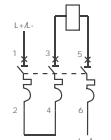

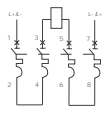
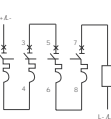
Ex9BP-H

10kA —C K

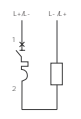
C

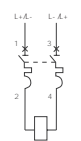
	mm	A	V DC			
 <p>1P</p> 	18	10	250	88079	Ex9BP-H 1P C 10A	
	18	16	250	88080	Ex9BP-H 1P C 16A	
	18	20	250	88081	Ex9BP-H 1P C 20A	
	18	25	250	88082	Ex9BP-H 1P C 25A	
	18	32	250	88143	Ex9BP-H 1P C 32A	
	18	40	250	88144	Ex9BP-H 1P C 40A	
	18	50	250	88145	Ex9BP-H 1P C 50A	
	18	63	250	88146	Ex9BP-H 1P C 63A	
	 <p>2P</p>  	36	10	500	88083	Ex9BP-H 2P C 10A
		36	16	500	88084	Ex9BP-H 2P C 16A
36		20	500	88085	Ex9BP-H 2P C 20A	
36		25	500	88086	Ex9BP-H 2P C 25A	
36		32	500	88147	Ex9BP-H 2P C 32A	
36		40	500	88148	Ex9BP-H 2P C 40A	
36		50	500	88149	Ex9BP-H 2P C 50A	
36		63	500	88150	Ex9BP-H 2P C 63A	
36		10	500	90048	Ex9BP-H 2P C 10A New	
36		16	500	90049	Ex9BP-H 2P C 16A New	
 <p>3P</p>  	54	10	750	88087	Ex9BP-H 3P C 10A	
	54	16	750	88088	Ex9BP-H 3P C 16A	
	54	20	750	88089	Ex9BP-H 3P C 20A	
	54	25	750	88090	Ex9BP-H 3P C 25A	
	54	32	750	88151	Ex9BP-H 3P C 32A	
	54	40	750	88152	Ex9BP-H 3P C 40A	
	54	50	750	88153	Ex9BP-H 3P C 50A	
	54	63	750	88154	Ex9BP-H 3P C 63A	
	54	10	750	90056	Ex9BP-H 3P C 10A New	
	54	16	750	90057	Ex9BP-H 3P C 16A New	
 <p>4P</p>  	72	10	1000	88091	Ex9BP-H 4P C 10A	
	72	16	1000	88092	Ex9BP-H 4P C 16A	
	72	20	1000	88093	Ex9BP-H 4P C 20A	
	72	25	1000	88094	Ex9BP-H 4P C 25A	
	72	10	1000	88155	Ex9BP-H 4P C 32A	
	72	16	1000	88156	Ex9BP-H 4P C 40A	
	72	20	1000	88157	Ex9BP-H 4P C 50A	
	72	25	1000	88158	Ex9BP-H 4P C 63A	
	72	10	1000	90064	Ex9BP-H 4P C 10A New	
	72	16	1000	90065	Ex9BP-H 4P C 16A New	
72	20	1000	90066	Ex9BP-H 4P C 20A New		
72	25	1000	90067	Ex9BP-H 4P C 25A New		
72	32	1000	90068	Ex9BP-H 4P C 32A New		
72	40	1000	90069	Ex9BP-H 4P C 40A New		
72	50	1000	90070	Ex9BP-H 4P C 50A New		
72	63	1000	90071	Ex9BP-H 4P C 63A New		

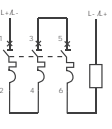
K

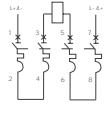
		mm	A	V DC		
 <p>1P</p> 		18	10	250	88095	Ex9BP-H 1P K 10A
		18	16	250	88096	Ex9BP-H 1P K 16A
		18	20	250	88097	Ex9BP-H 1P K 20A
		18	25	250	88098	Ex9BP-H 1P K 25A
		18	32	250	88159	Ex9BP-H 1P K 32A
		18	40	250	88160	Ex9BP-H 1P K 40A
		18	50	250	88161	Ex9BP-H 1P K 50A
		18	63	250	88162	Ex9BP-H 1P K 63A
	 <p>2P</p> 		36	10	500	88099
		36	16	500	88100	Ex9BP-H 2P K 16A
		36	20	500	88101	Ex9BP-H 2P K 20A
		36	25	500	88102	Ex9BP-H 2P K 25A
		36	32	500	88163	Ex9BP-H 2P K 32A
		36	40	500	88164	Ex9BP-H 2P K 40A
		36	50	500	88165	Ex9BP-H 2P K 50A
		36	63	500	88166	Ex9BP-H 2P K 63A
		36	10	500	90072	Ex9BP-H 2P K 10A New
		36	16	500	90073	Ex9BP-H 2P K 16A New
		36	20	500	90074	Ex9BP-H 2P K 20A New
		36	25	500	90075	Ex9BP-H 2P K 25A New
		36	32	500	90076	Ex9BP-H 2P K 32A New
		36	40	500	90077	Ex9BP-H 2P K 40A New
		36	50	500	90078	Ex9BP-H 2P K 50A New
	36	63	500	90079	Ex9BP-H 2P K 63A New	
 <p>3P</p> 		54	10	750	88103	Ex9BP-H 3P K 10A
		54	16	750	88104	Ex9BP-H 3P K 16A
		54	20	750	88105	Ex9BP-H 3P K 20A
		54	25	750	88106	Ex9BP-H 3P K 25A
		54	32	750	88167	Ex9BP-H 3P K 32A
		54	40	750	88168	Ex9BP-H 3P K 40A
		54	50	750	88169	Ex9BP-H 3P K 50A
		54	63	750	88170	Ex9BP-H 3P K 63A
		54	10	750	90080	Ex9BP-H 3P K 10A New
		54	16	750	90081	Ex9BP-H 3P K 16A New
		54	20	750	90082	Ex9BP-H 3P K 20A New
		54	25	750	90083	Ex9BP-H 3P K 25A New
		54	32	750	90084	Ex9BP-H 3P K 32A New
		54	40	750	90085	Ex9BP-H 3P K 40A New
		54	50	750	90086	Ex9BP-H 3P K 50A New
	54	63	750	90087	Ex9BP-H 3P K 63A New	
 <p>4P</p> 		72	10	1000	88107	Ex9BP-H 4P K 10A
		72	16	1000	88108	Ex9BP-H 4P K 16A
		72	20	1000	88109	Ex9BP-H 4P K 20A
		72	25	1000	88110	Ex9BP-H 4P K 25A
		72	32	1000	88171	Ex9BP-H 4P K 32A
		72	40	1000	88172	Ex9BP-H 4P K 40A
		72	50	1000	88173	Ex9BP-H 4P K 50A
		72	63	1000	88174	Ex9BP-H 4P K 63A
		72	10	1000	90088	Ex9BP-H 4P K 10A New
		72	16	1000	90089	Ex9BP-H 4P K 16A New
		72	20	1000	90090	Ex9BP-H 4P K 20A New
		72	25	1000	90091	Ex9BP-H 4P K 25A New
		72	32	1000	90092	Ex9BP-H 4P K 32A New
		72	40	1000	90093	Ex9BP-H 4P K 40A New
		72	50	1000	90094	Ex9BP-H 4P K 50A New
	72	63	1000	90095	Ex9BP-H 4P K 63A New	

## Ex9BP直流小型断路器

Ex9BP Series DC Miniature Circuit Breaker

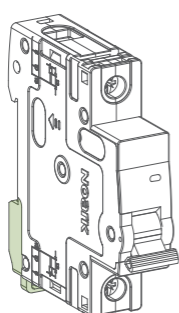

未按本说明书要求操作造成的不良后果，制造商将不承担责任。  
The manufacturer assumes no responsibility for unfavourable consequence resulting from the non-application or incorrect application of the instructions provided herein.

**NOARK 诺雅克**

## Ex9BP直流小型断路器

Ex9BP Series DC Miniature Circuit Breaker

### 外形尺寸 Dimension

单位：毫米  
Unit: mm

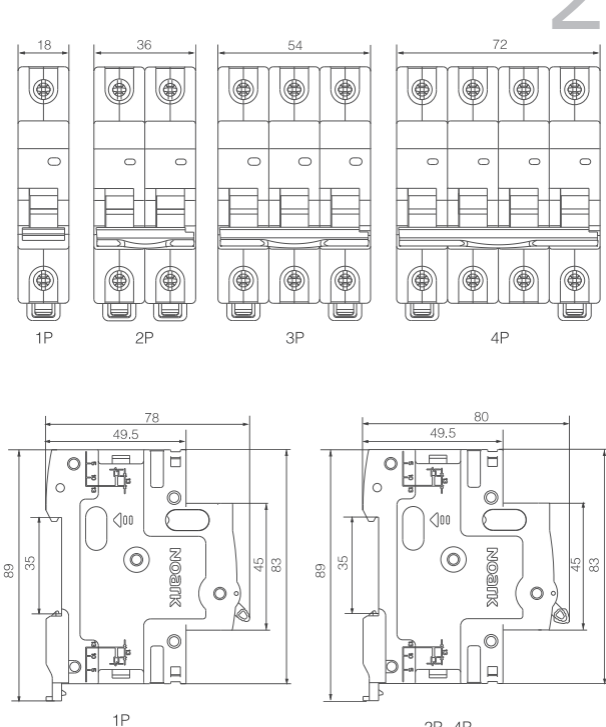

## Ex9BP直流小型断路器

Ex9BP Series DC Miniature Circuit Breaker

### 安装步骤 Installation

安装步骤 1 → 2  
Installation

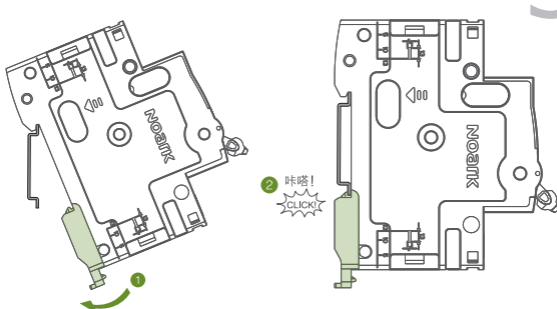

## Ex9BP直流小型断路器

Ex9BP Series DC Miniature Circuit Breaker

### 拆卸步骤 Removal

拆卸步骤 1 → 2 → 3  
Disassemble

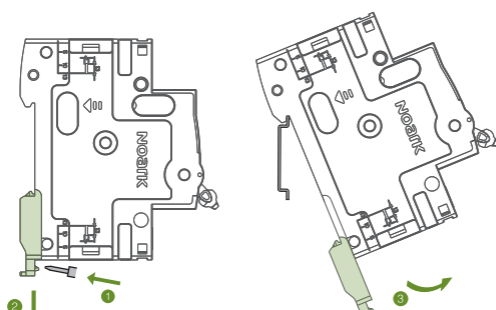

## Ex9BP直流小型断路器

Ex9BP Series DC Miniature Circuit Breaker

### 接线 Wiring

接线工具 Connection tool		2#螺丝刀 2# screw driver
接线能力(mm <sup>2</sup> ) Wiring capability		1-35mm <sup>2</sup>
拧紧力矩(Nm) Tightening torque		2-3.5Nm

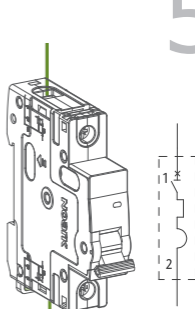

## Ex9BP直流小型断路器

Ex9BP Series DC Miniature Circuit Breaker

### 接线 Wiring

1P: 250VDC

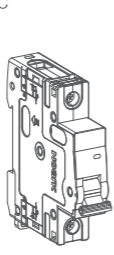

1P

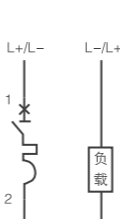

## Ex9BP直流小型断路器

Ex9BP Series DC Miniature Circuit Breaker

### 接线 Wiring

2P: 500VDC

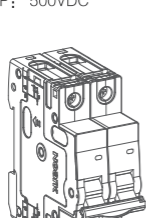

2P

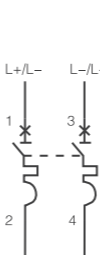

不接地系统

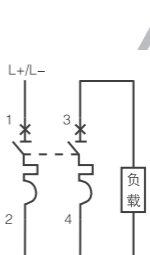

单极接地系统

## Ex9BP直流小型断路器

Ex9BP Series DC Miniature Circuit Breaker

接线 Wiring

# 8

3P: 750VDC

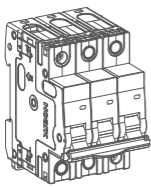

3P

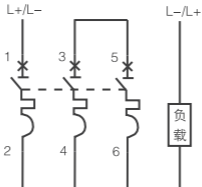

单极接地系统

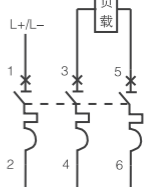

不接地系统

## Ex9BP直流小型断路器

Ex9BP Series DC Miniature Circuit Breaker

接线 Wiring

# 9

4P: 1000VDC

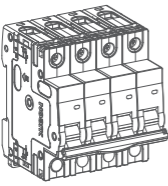

4P

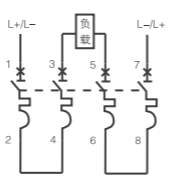

不接地系统

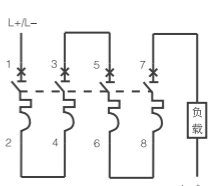

单极接地系统

## Ex9BP直流小型断路器

Ex9BP Series DC Miniature Circuit Breaker

指示 Indication

# 10

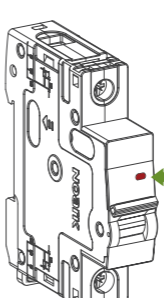
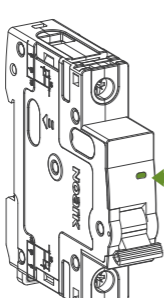

## Ex9BP直流小型断路器

Ex9BP Series DC Miniature Circuit Breaker

组装 Assemble

# 11

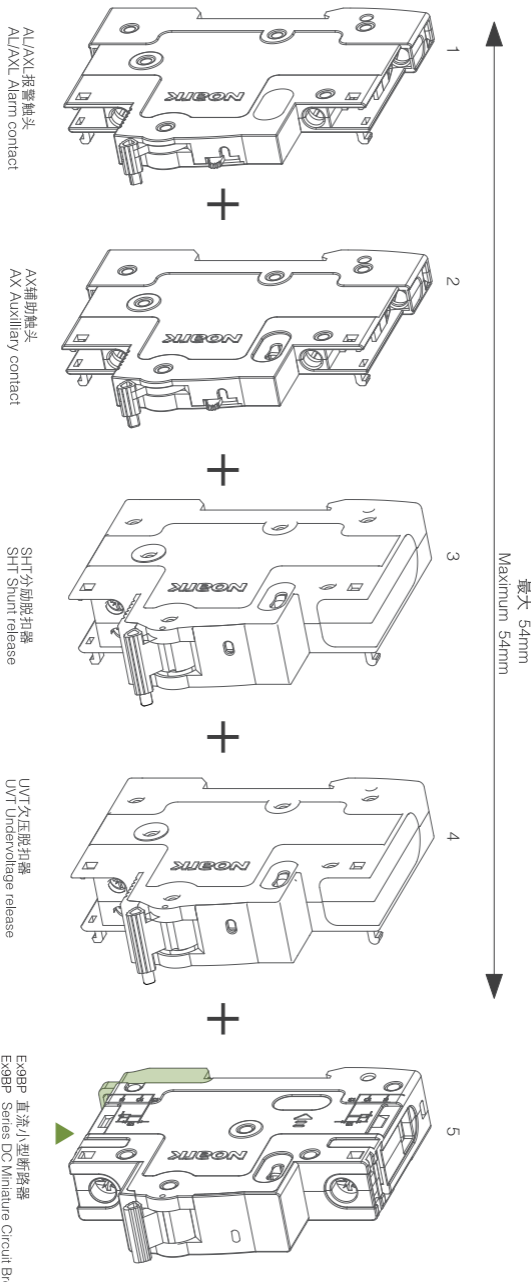

\*附件可单独与断路器拼装，也可以按顺序与其他附件组合后与小型断路器拼装。

\*Accessory can be combined with circuit breaker alone.Or accessories can combine themselves with other accessories at first and then with MCB

上海诺雅克电气有限公司

NOARK Electric (Shanghai) Co., Ltd.

地址：上海市松江区文合路855号

Add: 855 Wenhe Road, Songjiang District, Shanghai

电话：+86-21-3779 1111

Tel: +86-21-3779 1111



采用环保纸印刷

Printed with environmentally-friendly paper

本说明书解释权归NOARK所有。

The expression right of the instructions

are owned by NOARK.

客服热线 / Customer Service Hotline:



400-1092-111

Z9BP201108CE